

Article number: 0101021
 Description: Retaining ring A 8 DIN 471
 Spring steel
 Note: Fitted with ZGA pilers

Measures

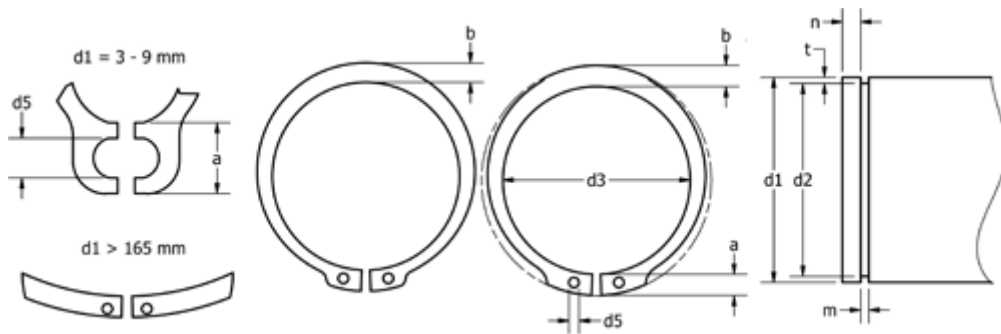

a max	= 3.2	FN kN	= 0.8	s	= 0.80
AN mm ²	= 4.9	FRg kN	= 2.00	t	= 0.20
b	= 1.5	FR kN	= 3.00	tol	= -0.06
d1	= 8	g	= 0.5	tol	= -0.05
d2	= 7.6	K kN-mm	= 14.20	tol	= +0,06-0,18
d3	= 7.4	m min	= 0.90	Tong	= ZGA-0
d5 min	= 1.2	n abl x 1000	= 96.0	Weight kg/1000	= 0.158
Description	= A8	Nominal drive	= 0.6		